

GAMME I S O

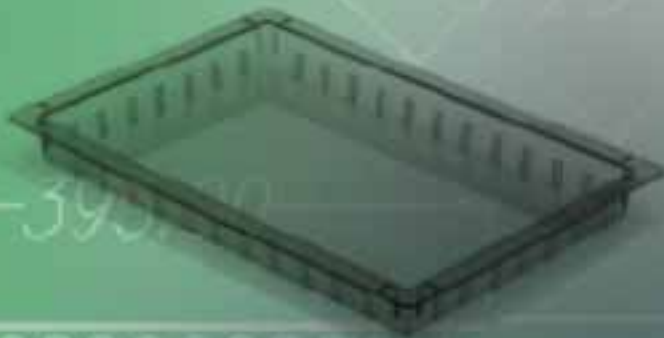

SAS S.I.C.A.H.

Domaine "Les Merisiers" - Lieu dit Les Merisiers - MONTRETOUT

77660 ST JEAN LES DEUX JUMEAUX

Tél. : 01 60 01 20 51 - Fax : 01 60 01 21 31

Mail : sicah2@wanadoo.fr



BAC ABS

600x400x50

- > Réf. : N.02 580 ABS
- > Descriptif : Bac
- > Matière : Abs
- > Dimensions : 600x400x50
- > Séparateur compatible :
D/ 400x50 - Réf. : N.02 581
D/ 600x50 - Réf. : N.02 582

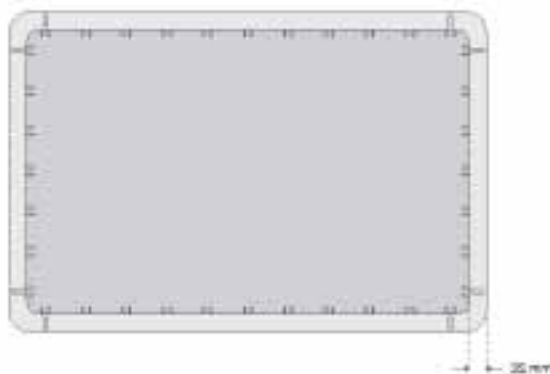
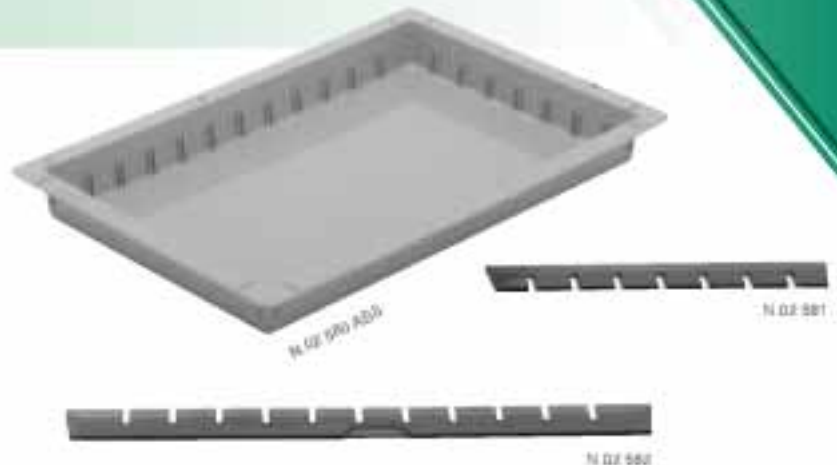

SAS S.I.C.A.H.

Domaine "Les Merisiers" - Lieu dit Les Merisiers - MONTRETOUT

77660 ST JEAN LES DEUX JUMEAUX

Tél. : 01 60 01 20 51 - Fax : 01 60 01 21 31

Mail : sicah2@wanadoo.fr



BAC ABS

600x400x100

- > Réf. : N.02 583 ABS
- > Descriptif : Bac
- > Matière : Abs
- > Dimensions : 600x400x100
- > Séparateur compatible :
D/ 400x100 - Réf. : N.02 584
D/ 600x100 - Réf. : N.02 585

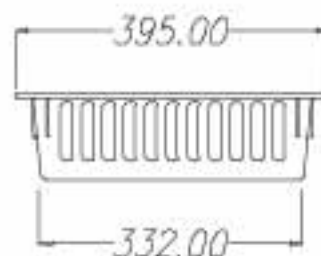
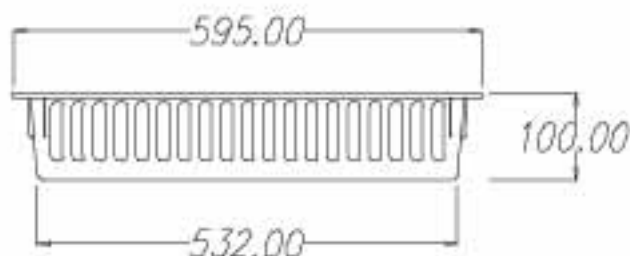
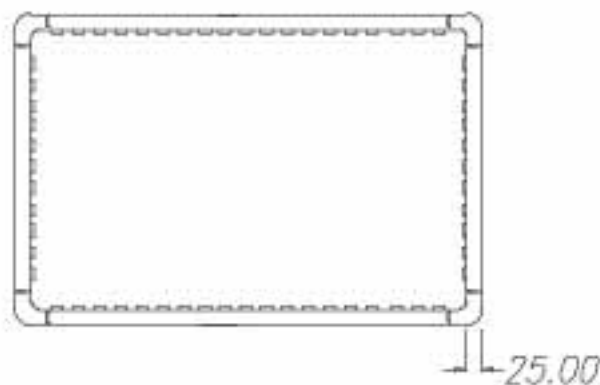
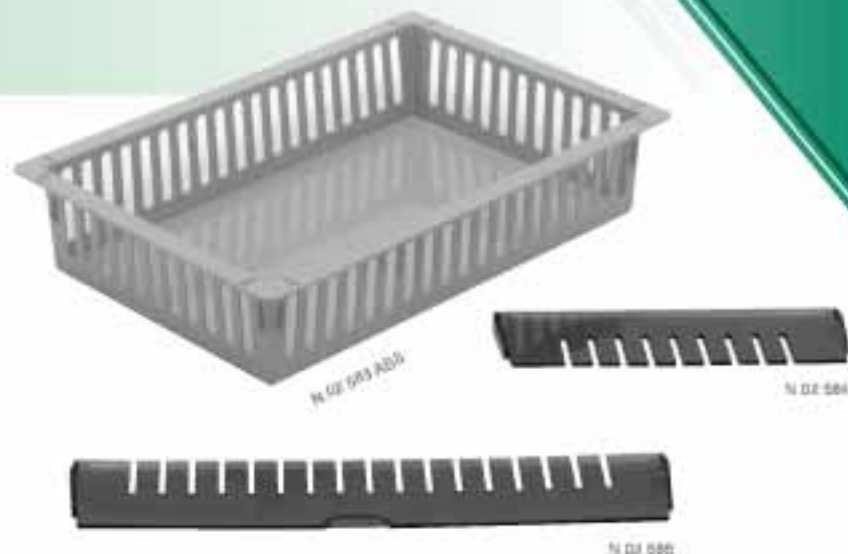

SAS S.I.C.A.H.

Domaine "Les Merisiers" - Lieu dit Les Merisiers - MONTRETOUT
77660 ST JEAN LES DEUX JUMEAUX
Tél. : 01 60 01 20 51 - Fax : 01 60 01 21 31
Mail : sicah2@wanadoo.fr



BAC ABS

600x400x200

- > Réf. : N.02 587 ABS
- > Descriptif : Bac
- > Matière : Abs
- > Dimensions : 600x400x200
- > Séparateur compatible :
D/ 400x200 - Réf. : N.02 588
D/ 600x200 - Réf. : N.02 589



N.02 587 ABS



N.02 588



N.02 589



25.00

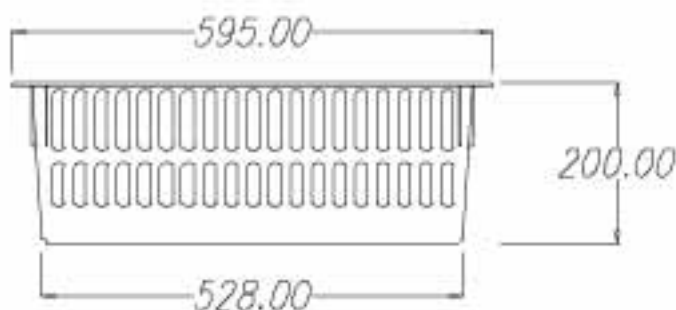

595.00

200.00

528.00

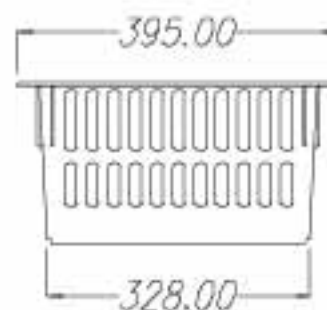

395.00

328.00

SAS S.I.C.A.H.

Domaine "Les Merisiers" - Lieu dit Les Merisiers - MONTRETOUT

77660 ST JEAN LES DEUX JUMEAUX

Tél. : 01 60 01 20 51 - Fax : 01 60 01 21 31

Mail : sicah2@wanadoo.fr



BAC POLYCARBONATE

400x300x100



- > Réf. : N.02 586
- > Descriptif : Bac
- > Matière : Polycarbonate
- > Dimensions : 400x300x100
- > Séparateur compatible, réf. : N.02 584

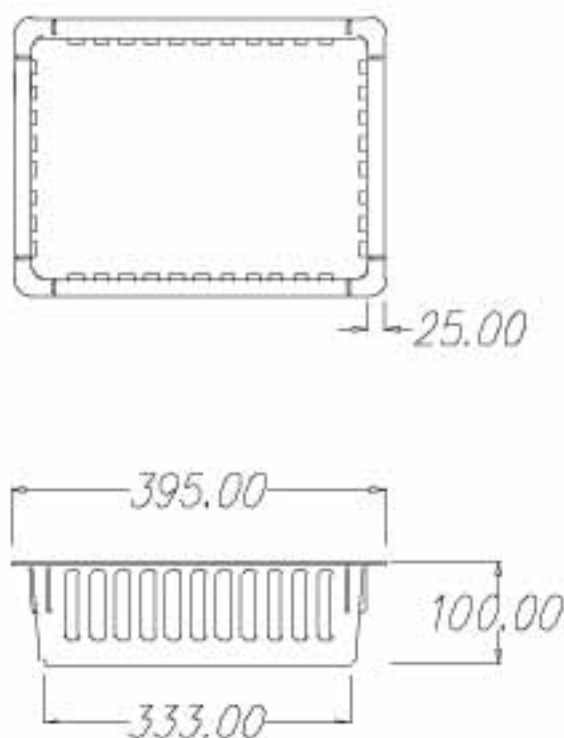

SAS S.I.C.A.H.

Domaine "Les Merisiers" - Lieu dit Les Merisiers - MONTRETOUT

77660 ST JEAN LES DEUX JUMEAUX

Tél. : 01 60 01 20 51 - Fax : 01 60 01 21 31

Mail : sicah2@wanadoo.fr



BAC POLYCARBONATE

400x300x200

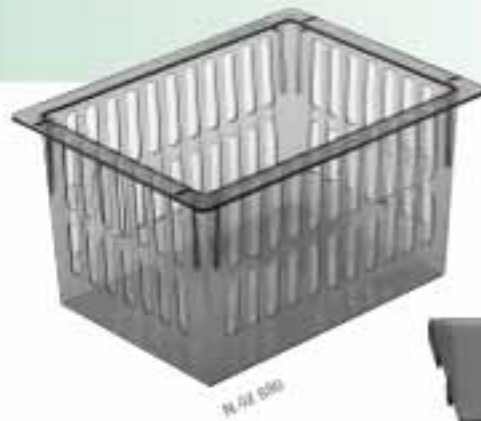

- > Réf. : N.02 590
- > Descriptif : Bac
- > Matière : Polycarbonate
- > Dimensions : 400x300x200
- > Séparateur compatible, réf. : N.02 588

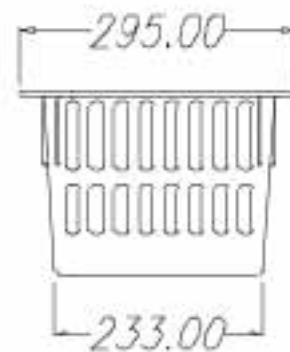
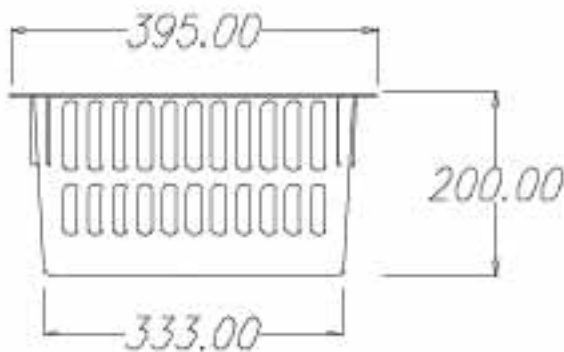
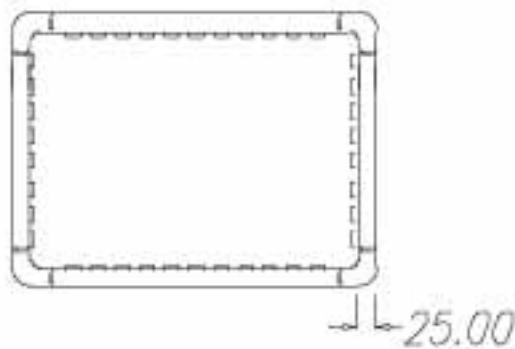

SAS S.I.C.A.H.

Domaine "Les Merisiers" - Lieu dit Les Merisiers - MONTRETOUT

77660 ST JEAN LES DEUX JUMEAUX

Tél. : 01 60 01 20 51 - Fax : 01 60 01 21 31

Mail : sicah2@wanadoo.fr



BAC POLYCARBONATE

600x400x50

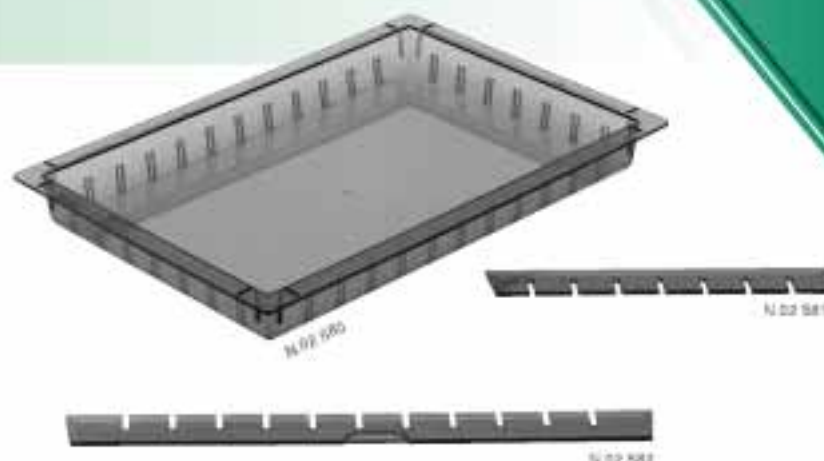

- > Réf. : N.02 580
- > Descriptif : Bac
- > Matière : Polycarbonate
- > Dimensions : 600x400x50
- > Séparateur compatible :
D/ 400x50 - Réf. : N.02 581
D/ 600x50 - Réf. : N.02 582

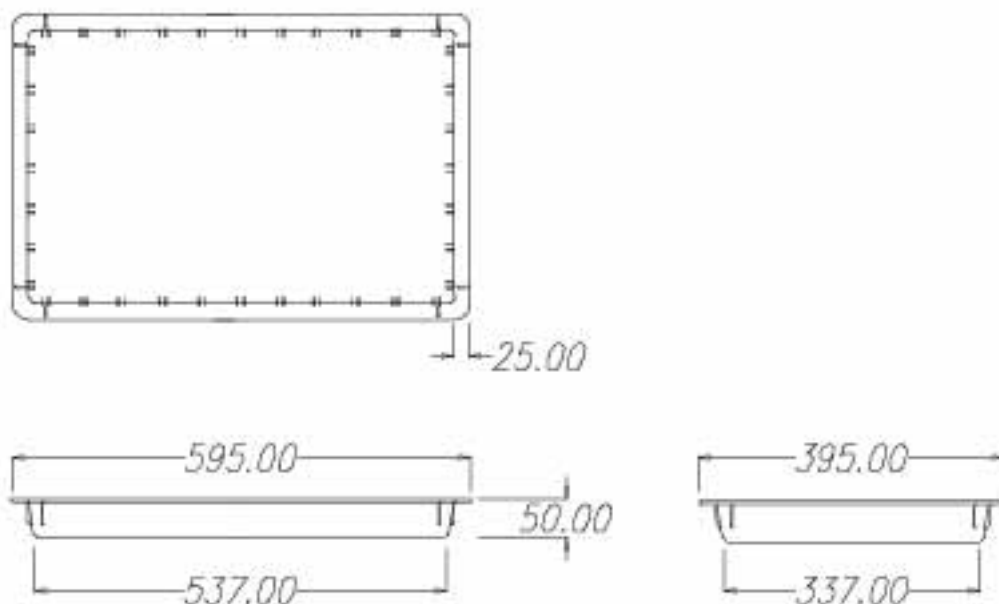

SAS S.I.C.A.H.

Domaine "Les Merisiers" - Lieu dit Les Merisiers - MONTRETOUT
77660 ST JEAN LES DEUX JUMEAUX
Tél. : 01 60 01 20 51 - Fax : 01 60 01 21 31
Mail : sicah2@wanadoo.fr



BAC POLYCARBONATE

600x400x200

- > Réf. : N.02 587
- > Descriptif : Bac
- > Matière : Polycarbonate
- > Dimensions : 600x400x200
- > Séparateur compatible :
D/ 400x200 - Réf. : N.02 588
D/ 600x200 - Réf. : N.02 589

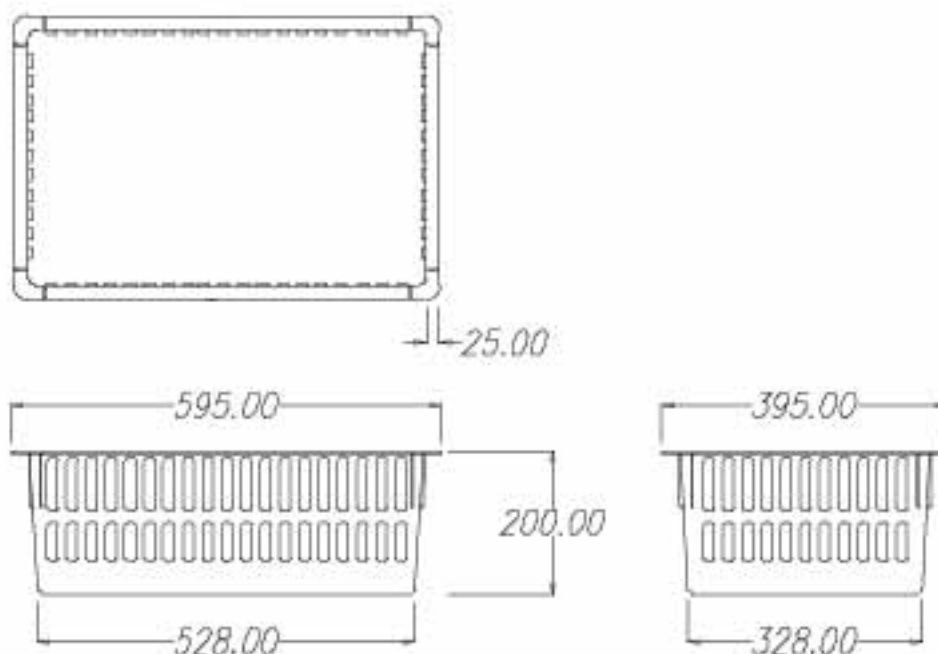

SAS S.I.C.A.H.

Domaine "Les Merisiers" - Lieu dit Les Merisiers - MONTRETOUT
77660 ST JEAN LES DEUX JUMEAUX
Tél. : 01 60 01 20 51 - Fax : 01 60 01 21 31
Mail : sicah2@wanadoo.fr



SÉPARATEURS

➤ Matière : polycarbonate

Réf. : N.02 581 - D/ 400x50

Réf. : N.02 582 - D/ 600x50

Réf. : N.02 584 - D/ 400x100

Réf. : N.02 585 - D/ 600x100

Réf. : N.02 588 - D/ 400x200

Réf. : N.02 589 - D/ 600x200

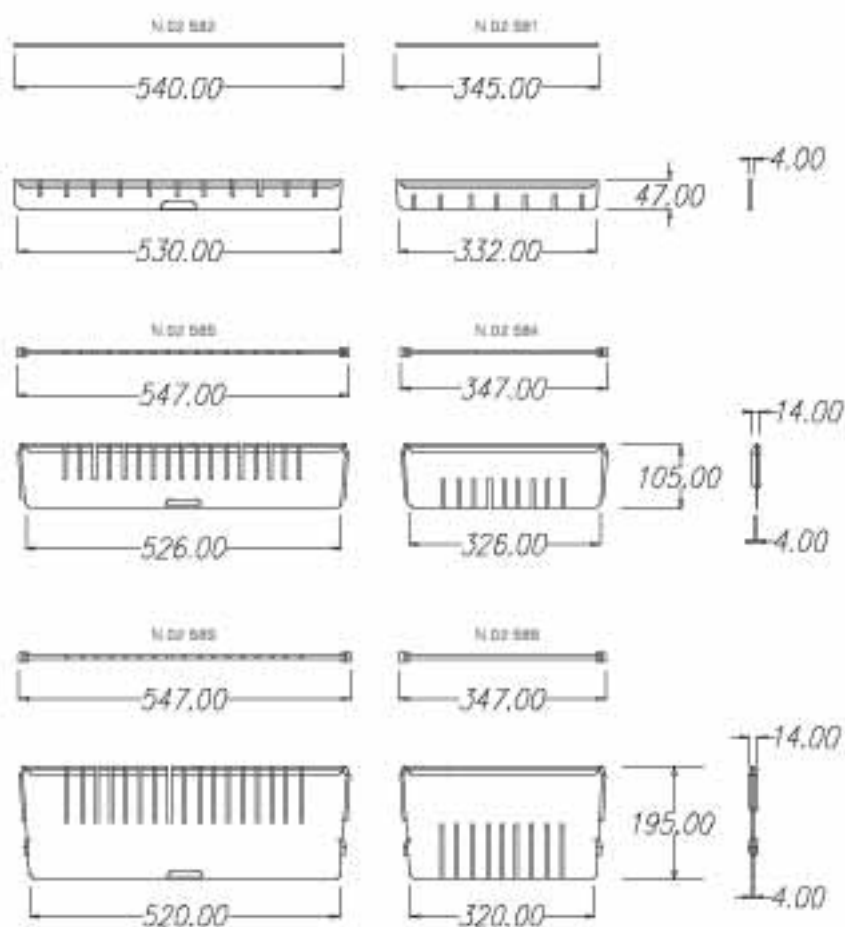
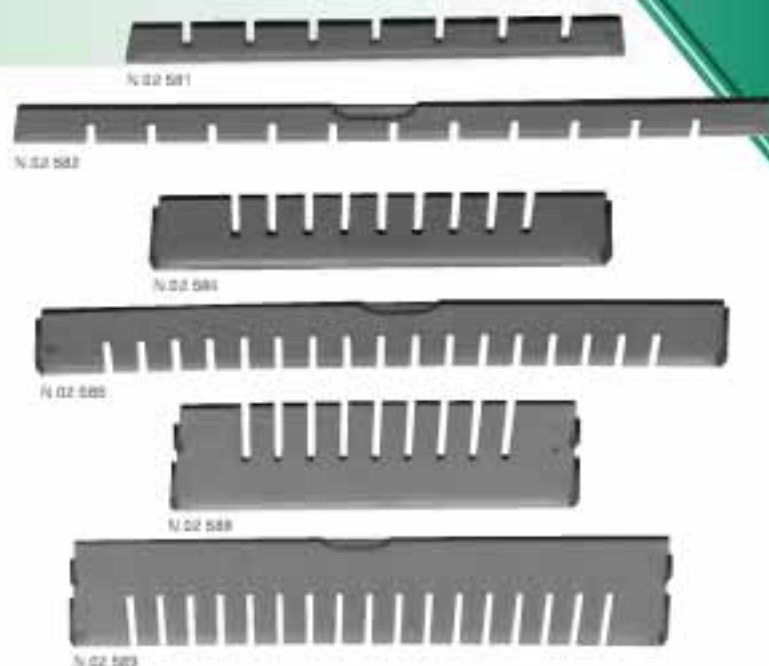

SAS S.I.C.A.H.

Domaine "Les Merisiers" - Lieu dit Les Merisiers - MONTRETOUT

77660 ST JEAN LES DEUX JUMEAUX

Tél. : 01 60 01 20 51 - Fax : 01 60 01 21 31

Mail : sicah2@wanadoo.fr



BAC POLYPROPYLENE

600x400x200



N.02 595

- > Réf. : N.02 592
- > Descriptif : Bac
- > Matière : Polypropylène
- > Dimensions : 600x400x200
- > Séparateur compatible :
D/ 400x200 - Réf. : N.02 594
D/ 600x200 - Réf. : N.02 595

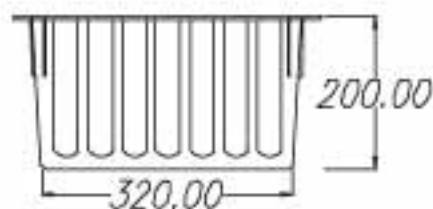
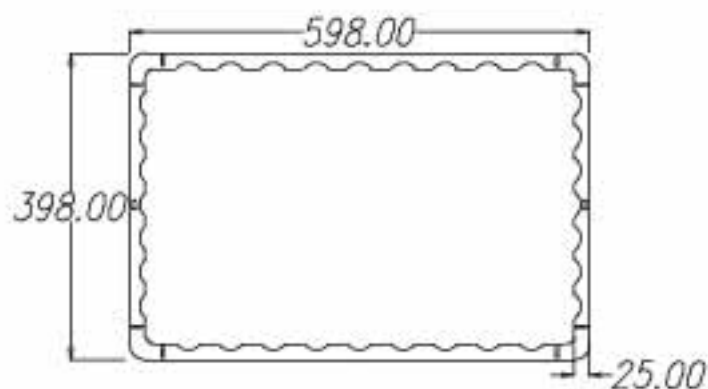

SAS S.I.C.A.H.

Domaine "Les Merisiers" - Lieu dit Les Merisiers - MONTRETOUT

77660 ST JEAN LES DEUX JUMEAUX

Tél. : 01 60 01 20 51 - Fax : 01 60 01 21 31

Mail : sicah2@wanadoo.fr



COUVERCLE POLYPROPYLÈNE POUR BAC 600x400

(Réf. N.02.593)



- > Réf. : N.02 593
- > Descriptif : Couvercle
- > Dimensions : 600x400x20
- > Matière : polypropylène

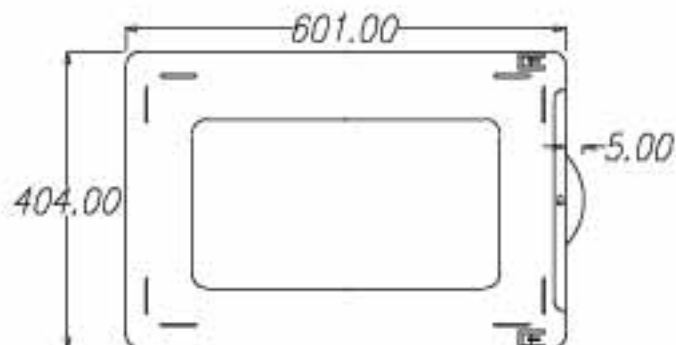

SAS S.I.C.A.H.

Domaine "Les Merisiers" - Lieu dit Les Merisiers - MONTRETOUT

77660 ST JEAN LES DEUX JUMEAUX

Tél. : 01 60 01 20 51 - Fax : 01 60 01 21 31

Mail : sicah2@wanadoo.fr



SÉPARATEURS POUR BACS POLYPROPYLÈNE

> Matière : polypropylène

Réf. : N.02 595 - D/ 600x200

Réf. : N.02 594 - D/ 400x200

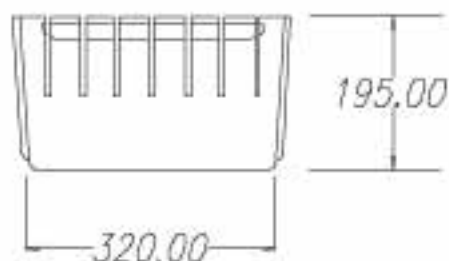
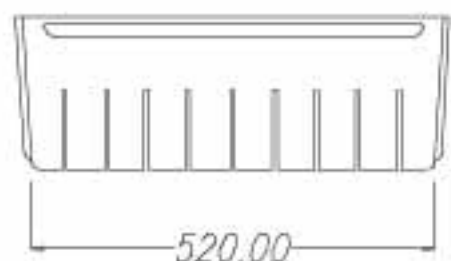
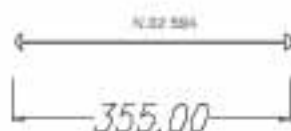
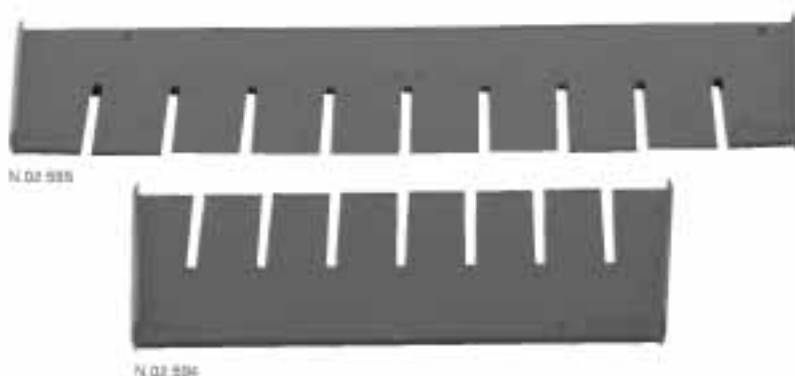

SAS S.I.C.A.H.

Domaine "Les Merisiers" - Lieu dit Les Merisiers - MONTRETOUT
77660 ST JEAN LES DEUX JUMEAUX

Tél. : 01 60 01 20 51 - Fax : 01 60 01 21 31

Mail : sicah2@wanadoo.fr



PORTE ÉTIQUETTE POUR BAC ISO

- > Porte étiquette souple :
Matière : cristal
Réf. : N.02 412 S / Dim. : 88 x 80 x 7 mm
- > Porte étiquette rigide :
Matière : polypropylène
Réf. : N.02 412 R / Dim. : 90 x 59 x 10 mm
- > Étiquette :
Matière : polypropylène
Réf. : N.02 412 E / Dim. : 85 x 54

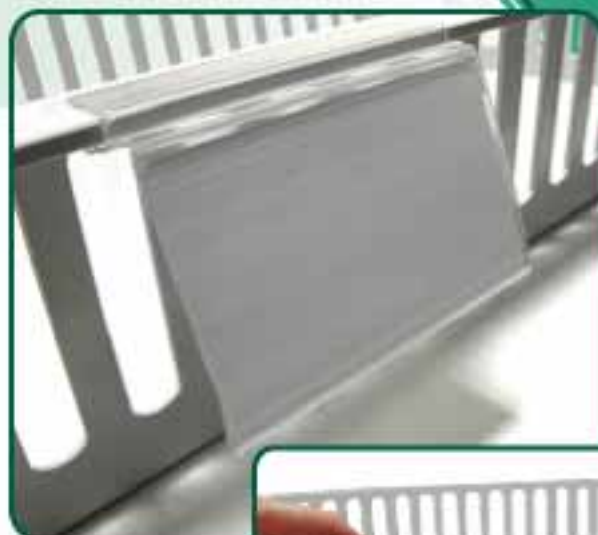

N.02 412 S

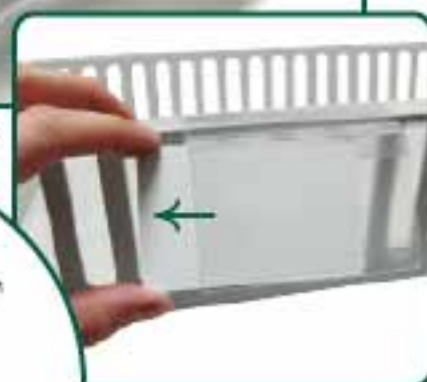

N.02 412 S



N.02 412 R



N.02 412 R

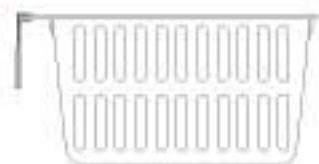
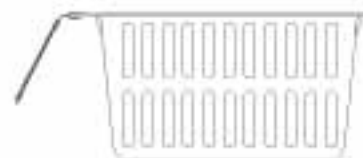

SAS S.I.C.A.H.

Domaine "Les Merisiers" - Lieu dit Les Merisiers - MONTRETOUT

77660 ST JEAN LES DEUX JUMEAUX

Tél. : 01 60 01 20 51 - Fax : 01 60 01 21 31

Mail : sicah2@wanadoo.fr